

1. Summary

Australian Sound Systems Model A 13 valve amplifier. S.N. 95. \$80 private sale Jan 2012

Three input (MIC, PU, Radio) channel PA amplifier. MIC input to 6J7 triode preamp then to 6J7 triode, which has common bypassed cathode with PU input to 6J7 triode. Preamp outputs mixed to PI stage. Voltage divider PI common cathode biased 6SN7. 6V6G cathode biased PP; 25k 10W & mica RC snubber P-P; screens direct to B+.

Output Transformer	No markings (but partly spray painted), Ferguson OP9 10k, 6k6, 5kΩ PP; 125, 250, 500Ω. 15W
Power Transformer	Enclosed – clear plastic terminals. 350-0-350V ?mA; 5V ~2A; 6V-0-6V ~2A; 0-110-220-240-260V
Choke	No markings except 150mA on base Bakelite sheet.
POTs	Aerovox(?).
Caps	Ducon Aerovox; Ducon Ceramicon; Ducon mica; Ducon PT 273
Resistors	Tube & dot code; Haigh ww;
Valves	6V6G x2: Radiotron V8 6J7 x3: 6SN7GT x1: Radiotron V8 5V4G x1: Miniwatt 33 H26
Light	ISMAY 240V 15W red

Good general condition but chassis with some surface rust. Original – no repairs – possibly the OT and choke and output octal connectors (now a board with ANT spring terminals) were replaced at some time. 6V6 250Ω 5W common cathode failed. Wire insulation hardened. Mains terminals via clear plastic terminals. Cables secured using chassis soldered links with insulation. Chassis punched for alternative choke, and other power supply parts. Wingnut mounting bolts extending from bottom of chassis for mounting to a table (?).

Unknown: VIB.I and VIB.II cable entry on side wall.

1.1 Issues

Mains terminal box on outer side wall. Exposed P.U. and octal terminals on side wall. Fuse for AC using fuse wire between pins on 4-pin plug on outer side-wall. Power socket with exposed neutral on outer side wall. Neutral switched and fused. Wire insulation. Degraded parts and vibration rubbers. Leaky coupling caps. PA OT impedances. 6V6's not suited to low OT primary impedance.



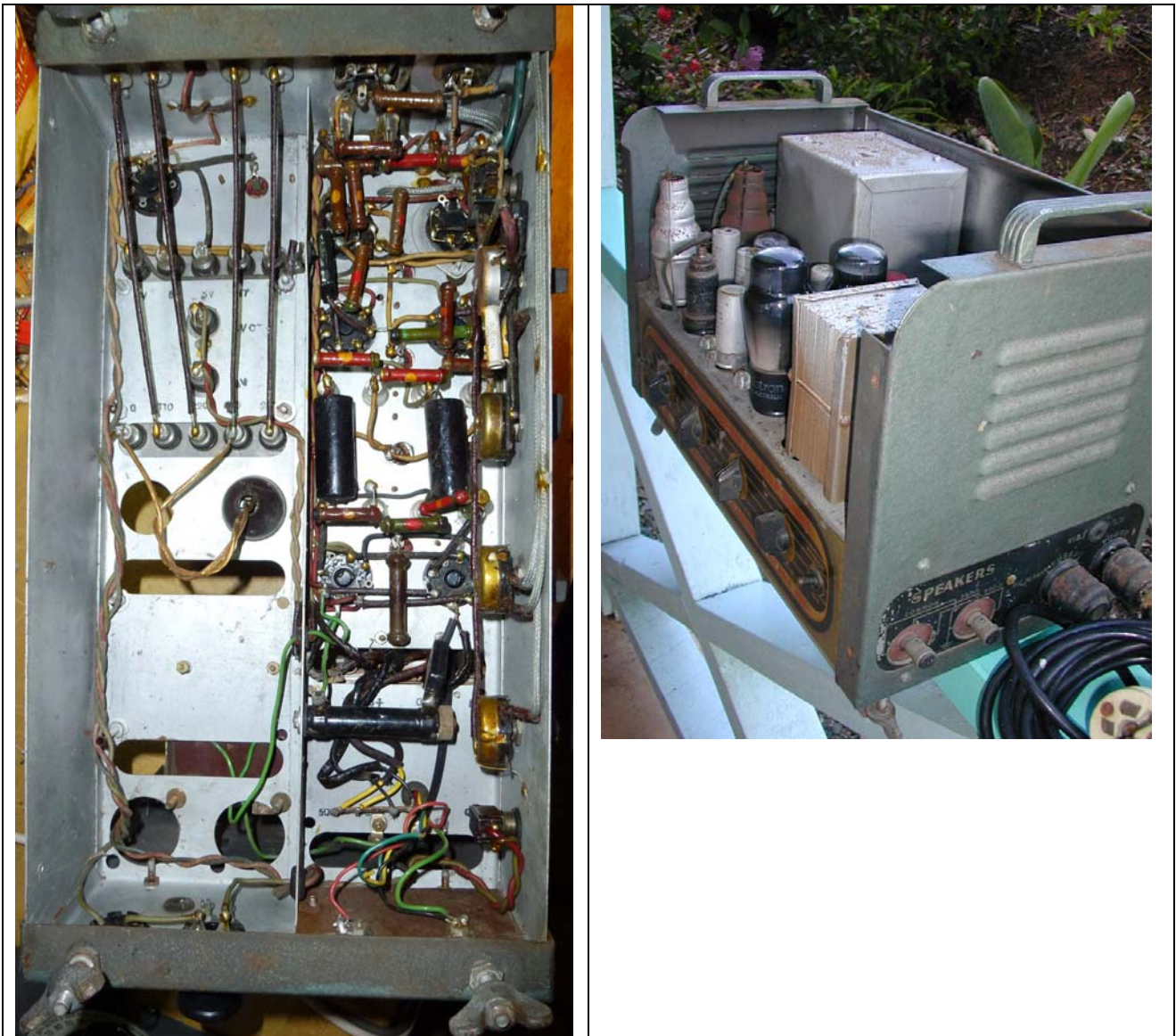

2. Modifications

- Replaced transformer internal cables and routed HT CT to outside (rather than soldered to chassis) and split the heater connection and routed remaining terminal outside.
- Added nomex insulation to choke winding shoulders (winding was moving on centre leg, and two wires were splayed near to core), and also between chassis and base terminals. A core lamination is flapping – causes a dink when current is applied.
- Added 10R cathode sense resistors and 270R screen stoppers, and 10k grid stoppers on 6V6's.
- Separate 6V heaters with humdingers; preamp tubes with humdinger pot.
- 6J7's all changed to 4k7 cathodes and 100k anode loads in triode mode, as per 1941 Radiotronics recommendation. Added 47k or 4k7 grid stoppers at top terminal spring.
- Distributed star 0V scheme, with isolated input socket.
- MOV-R protection of OT – 2x 330VDC and 2k2 per half-winding.
- Replaced all electrolytics with 10uF 350VAC poly.
- Retained all old resistors.
- MIC Tone pot used as treble boost across top of MIC GAIN pot in Fender Tweed 5F2-A style.

- PICKUP Tone pot used as anode AC load network style with series LC for scalloped attenuation about 1kHz. Spare pot end tied to wiper. Inductor is 0.2H 12V G2R relay coil with pivot arm glued in slightly gapped position and heatshrinked.
- Disconnected external 4-pin and 8-pin connectors. Used 4-pin fuse connector for 6V6 cathode voltage/current sensing.
- Use OT 125 to 250Ω secondary winding for 16Ω speaker output; 125Ω tap (midpoint) is grounded.
- 6L6/6L6G ST tubes are a bit too large to easily fit. Non-ST and 7027A allow more space. Pins 1 and 6 on base are left unconnected to allow use of 7027A. Heater winding rating of (expected) 2A is fine.
-
- Indicator on front panel.
- Replace 410Ω with 390Ω 10W. Take final measurements.
- Base and feet. Photo of underside.

3. Measurements

Megger tested 1kV on PT, OT primary and choke windings to chassis – all OK.

Voltage rail regulation.

Rail		330R cathode			
VS1		363			
VS2	400	351			
VS3	330				
VS4	278				
VS5	247				
Cathode PP V,mA,mA		22.9,34,36 11.5+11.5W			
Cathodes: V1,V3,V2,V4	5.4,5.9, 6.1,3.0				
Heater					
Sec HT					

Pri DCR: 0-240V = 17.3R; 0-260V = 19.7R

Sec DCR: 119+127 = 246R

12VAC 50Hz nominal applied to output transformer CT to Pri (one side)

Winding	Voltage rms	Turns ratio; Impedance for 10K pri; Spec level; Notes
Pri P-HT:	11.62, 11.55	
Pri: YL to YL	9.39, 9.4	; 6577Ω; 6600Ω;
Pri: BK to BK	8.20, 8.25	; 5041Ω; 5000Ω;
Sec: BLK to RED	5.22	; 508Ω; 500Ω; 100T
Sec: BLK to GRN	3.67	; 251Ω; 250Ω; 70T
Sec: BLK to YEL	2.6	; 126 Ω; 125Ω; 50T

Output transformer primary DC resistance – all windings with common CT:

plate-to-plate DCR: 77+85 = 162R

Y-Y DCR: 63+69 = 132R

BK-BK: 55+59 = 114R

Output transformer secondary DC resistance:

BK-RD: 11.6R

BK-GRN: 7.6R

BK-YL: 5.5R

500 to 250 winding (red to grn) = 46Ω impedance (30% windings)

250 to 125 winding (grn to yel) = 21Ω impedance (20% windings)

Choke. DCR=160Ω. 13.2H @ 54mA; 9.8H @ 94mA; 5.1H @ 154mA; 3.8H @ 191mADC.

3.1 DC heaters for preamps

Measurements with VAC=220V; VS2=350V; Vcathode=24.4V. 12V battery via LM396K regulator to 6.2VDC for heating V1-V4. V5-V6 powered from 6.3VAC heater 2.

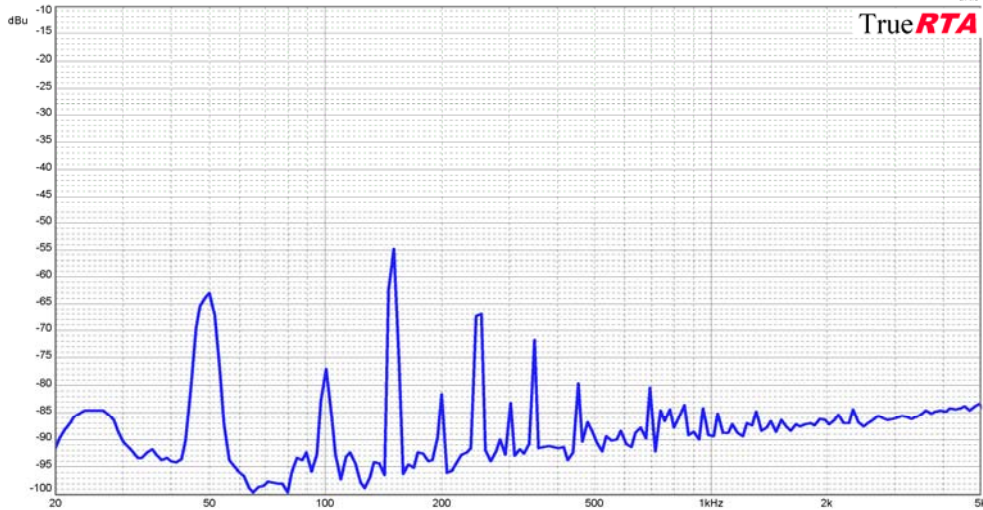

Pot1=0%; Pot2=100%; PI and output stage noise floor

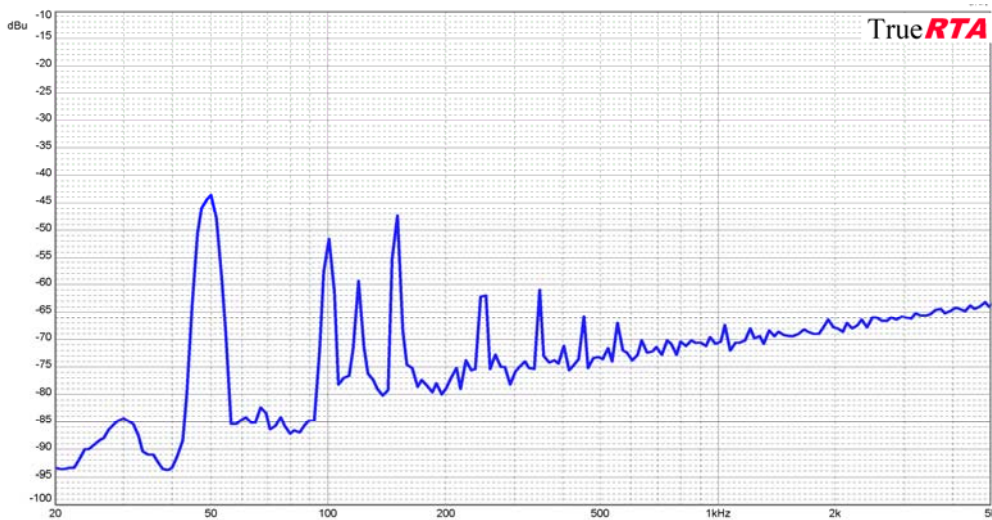

Pot1=100%; Pot2=100%; total noise floor

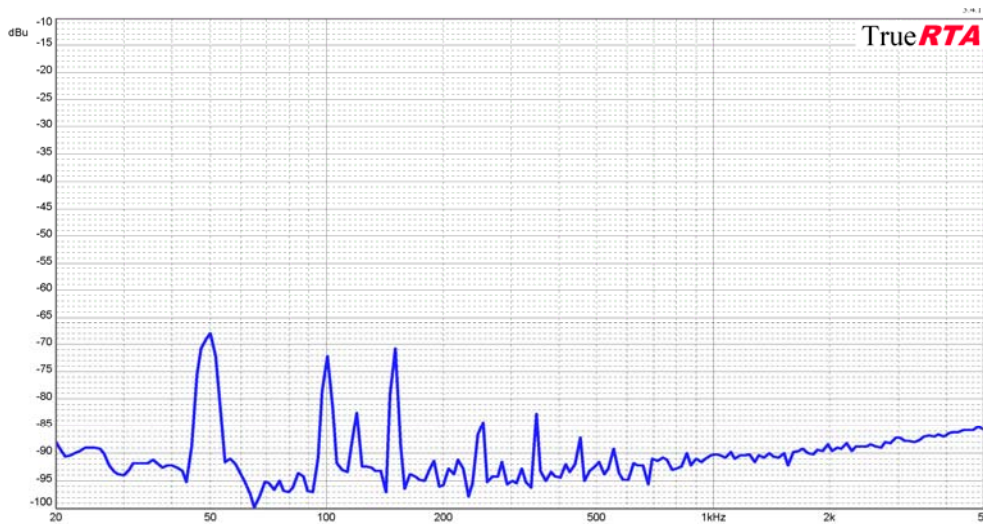

Pot1=100%; Pot2=50%;

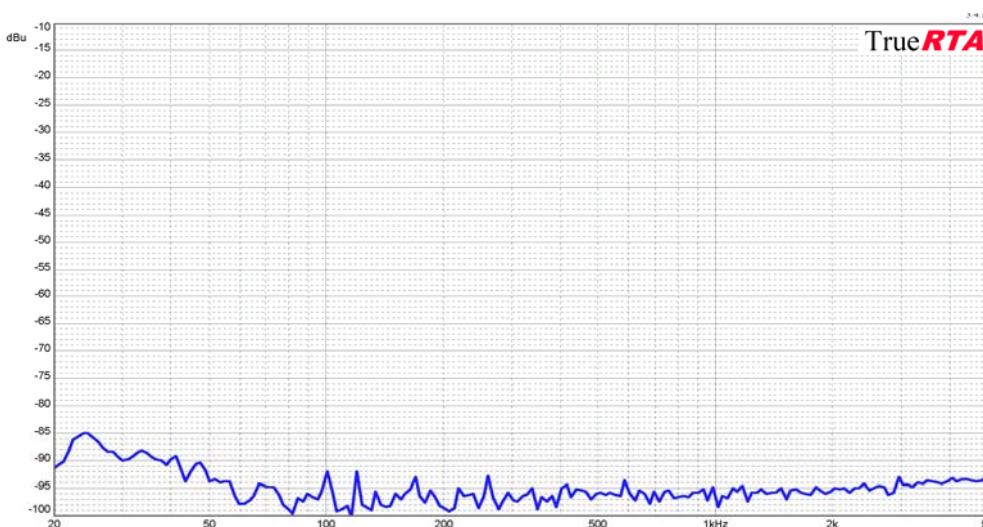

Pot1=0%; Pot2=100%; output grids shorted to 0V; output stage noise floor. Note 0dB was max cranked fundamental level.

3.2 AC heaters for preamps

Measurements with VAC=220V; VS2=350V; Vcathode=24.4V. V1-V4 powered from Heater 1. V5-V6 powered from 6.3VAC heater 2.

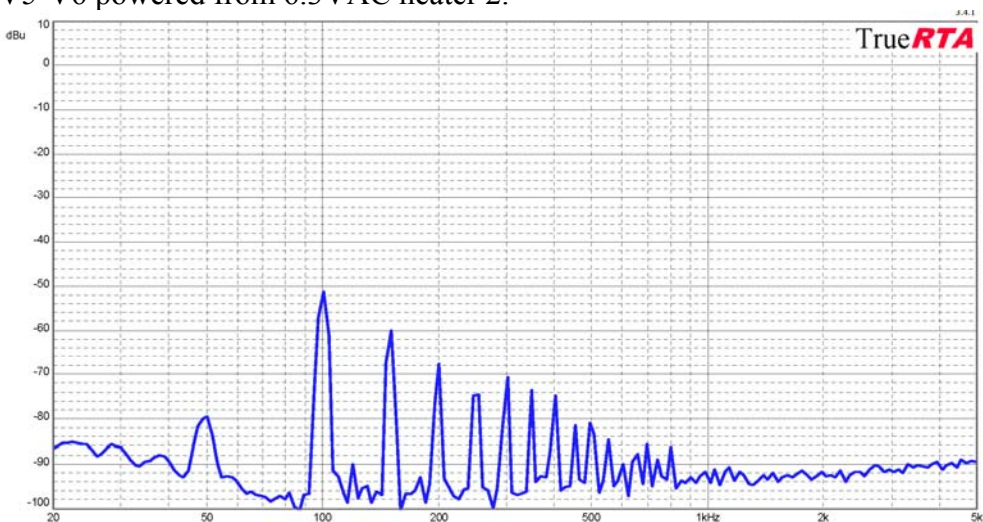

Pot1=0%; Pot2=100%; PI and output stage noise floor

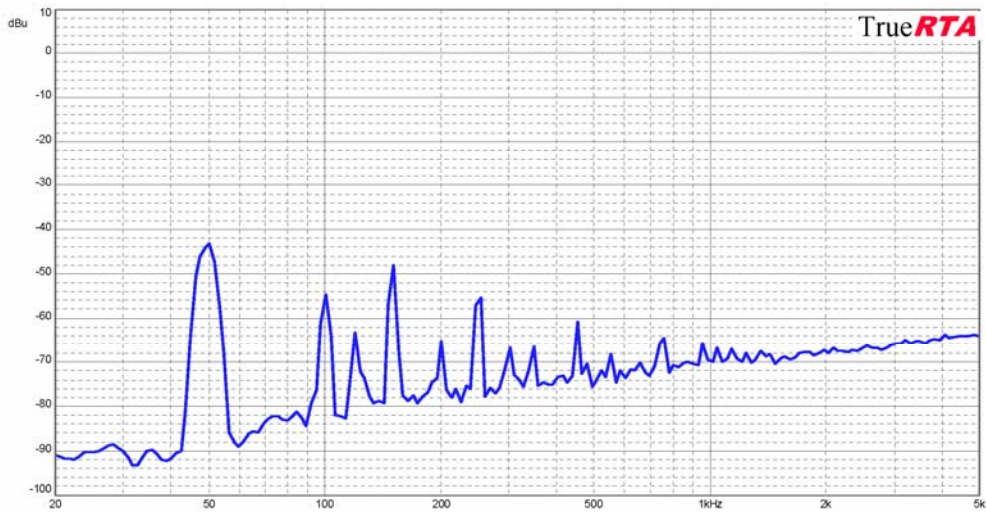

Pot1=100%; Pot2=100%; total noise floor

3.3 Tone Controls

Measurements with VAC=220V; VS2=350V; Vcathode=24V. V1-V4 powered from Heater 1. V5-V6 powered from 6.3VAC heater 2.

Tone pots 50%

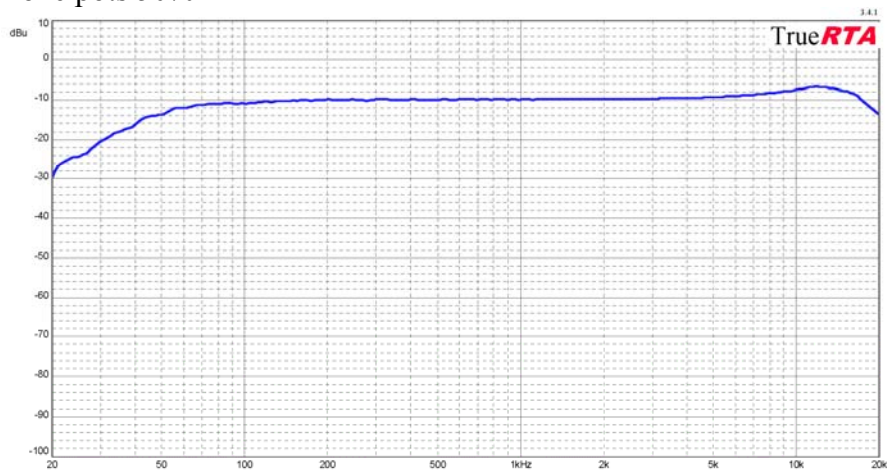

Pick-up Tone at 0%

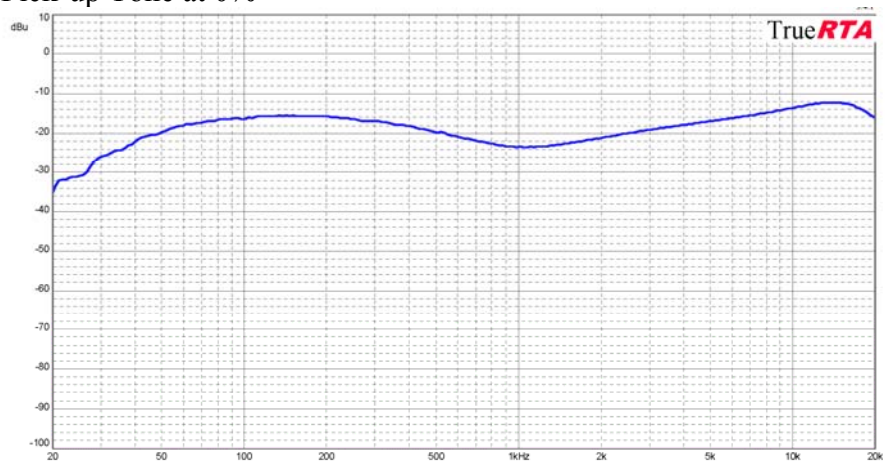

3.4 Over-drive

Measurements with VAC=220V; VS2=350V; Vcathode=24V. V1-V4 powered from Heater 1. V5-V6 powered from 6.3VAC heater 2. 17Ω load. 1kHz. Output stage over-drive only.

Over-drive waveforms at about 12W, 13.5W, 15W respectively:

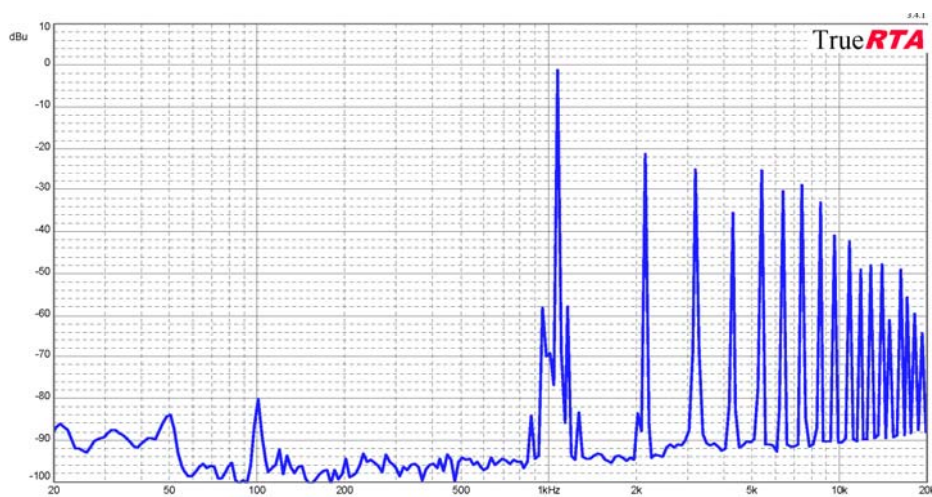
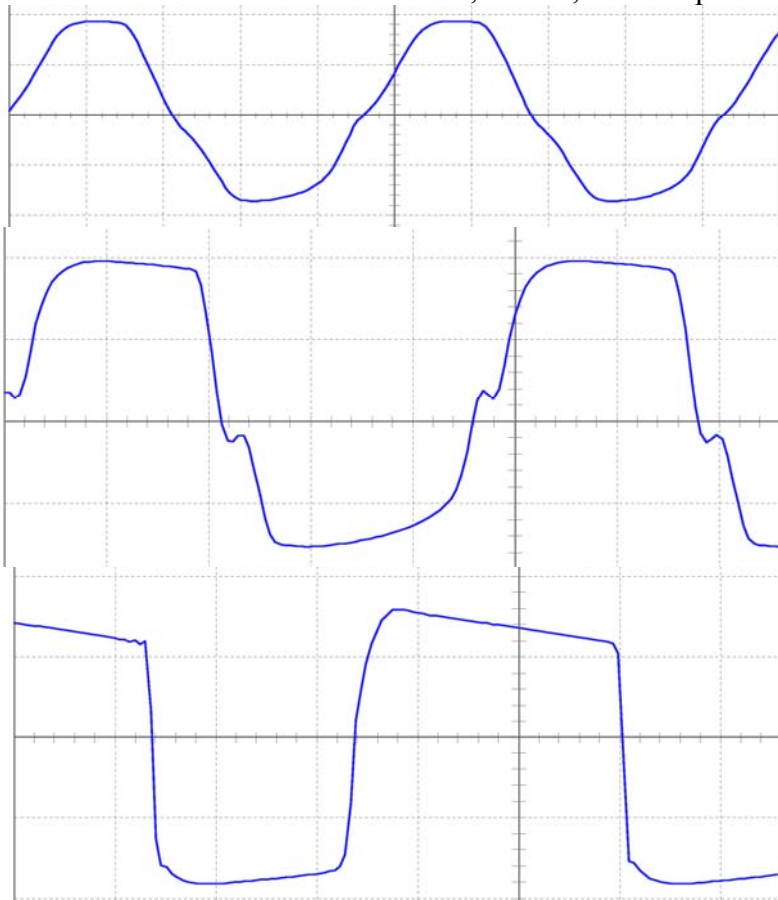

Spectrum at about 13Wrms

4. Comments so far

4.1 Input Stage

6J7, V1; VS3 = 250V; Va=130V; Rk=4k7; Vk=5V; Ia=1.0mA; RLdc=100k.
 [measured:V, V, V1

Available swing is 250-30-10=210V. Aim for 120V anode voltage and 1mA anode current at idle.

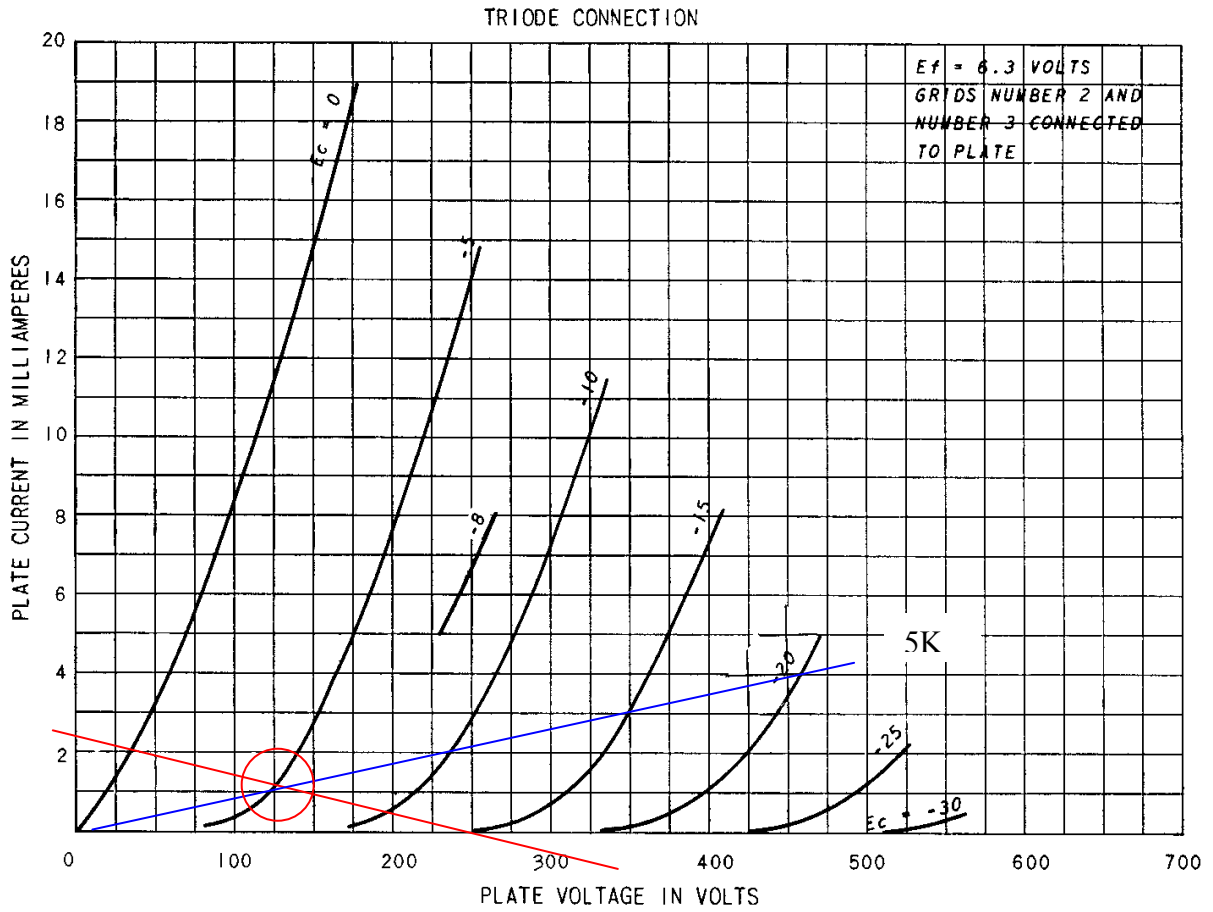

4.2 PI stage – 6SN7

6SN7, V4; VS3 = 250V; Va=60V; Rk=1k5; Vk=3V; Ia=1.0mA; RLdc=240k.
[measured:V, V, V1

Aim for 120V anode voltage and 1.5mA anode current at idle – use parallel load resistors.

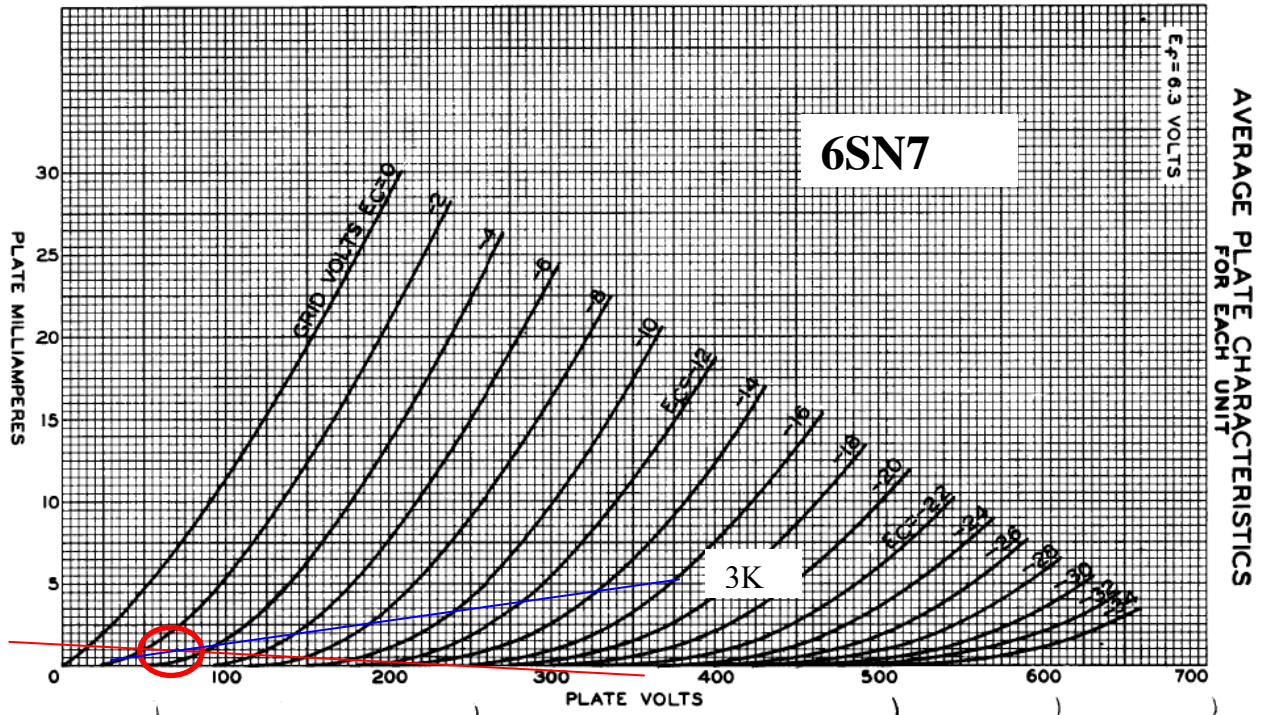

4.3 Output Stage

In this Class AB push-pull output stage, one tube is pushed into conduction and the other tube is pulled into cutoff, and there is a region of overlap where both tubes conduct equivalent levels of current. The cathodes are grounded, and each tube operates in a fixed bias mode with a negative gate voltage. A 16Ω speaker in to a 21Ω nominal impedance relates to a nominal 7k6Ω PP impedance for the 10k PP primary windings. The 7k6Ω impedance plate-to-plate OPT from Ferguson (OP9), presents each tube with a 3.8kΩ load impedance around cross-over, moving to an 1.9kΩ load impedance (Class B) at high signal levels - with a resistance matched secondary load.

As the output loading increases, the supply voltage VS2 to the output valve plates sags from about 400V to about 350V. Effective plate voltage will be lower than VS2 by an amount up to ~17V due to OPT half resistance of about 80Ω with a peak current of up to about 100mA, and also the cathode bias voltage which will change with the loading dynamics due to the bias bypass capacitor. Cathode bias can move between idle level of 30V and up to possibly 60V (see below). So min anode cathode voltage is about $350 - 17 - 60 = 250V$.

The screen supply VS2 will likely track somewhat closely with VS2 for sustained output loading, and correspondingly sag from about 375V to about 325V under heavy load on VS1. Screen current level also increases as Vg approaches 0V, possibly from about 5-10mA idles to about 20mA, which lowers VS2 by an additional $550\Omega \times 0.01A = 5V$. The voltage at the screen is further lowered by an additional ~10Vpk across the 270R screen stopper resistor, as well as the cathode bias voltage change described above. The idle screen voltage is about $325 - 30 = 295V$, and at peak swing may sag down to about $325V - 5V - 10V - 60V = 225V$ level. However the instantaneous screen voltage will interact with the peak plate current achieved, and some steady state equilibrium will occur where drooping screen voltage will lower peak plate current which will raise the supply rails.

The output valve idle bias current is based on 70% of the maximum recommended plate dissipation of 19W for the 6L6: $I_{bias} = P_d / V_b = 13W / (425V - 25V) = 33mA$. Note that raising the idle current will sag the supply rails, and raise the cathode bias voltage, which will both lead to a lower effective plate voltage. The grid bias voltage required for this current is significantly influenced by the screen voltage (ie. ~-20V at Vs=250V; ~-XXV at Vs=300V), however tube graphs are not available for higher screen levels, but can be inferred. A 330Ω 10W common cathode gives about 25V based on about 10-15% screen current.

At idle, the screen is close to the plate voltage (~370V), and the gate bias voltage needs to be about 30V, ie. bias resistor = $30V / (2 \times 24mA) = 680\Omega$. At max sustained overdrive signal the bias voltage may get close to $680\Omega \times 100mA_{pk} \sim 60V$, and hence the resistor power rating needs to be at least 10W.

The following graph shows the characteristic curves for 6V6 with a fixed screen voltage of 250V. The curves for screen voltage >250V will be somewhat similar but expanded vertically. Assuming a bias point of 24mA at 380V-30V = 350V, then plate dissipation is 8.4W. The initial loadline trajectory is along a 5kΩ loadline for small signals where both tubes are conducting – the loadline going through the bias point. The final loadline trajectory for heavy loading (high plate current) is along a 2.5kΩ loadline – this loadline is aligned with the sagged effective plate voltage of about 300V, and extends out to the 0V gate level. This 2.5kΩ loadline indicates a peak plate current of 100mA would be needed for input grid voltage reaching 0V (difficult to predict and dependant on steady state or dynamic conditions).

For a peak plate current of 110mA, then the nominal output power of the amplifier would be: $(I_{pk})^2 \times R_{pp} / 8 = 0.11 \times 0.11 \times 10k / 8 = 15W$. For this maximum signal condition, the rms OPT current draw is likely about 70mA (64% of peak), and the average VS2 power consumed is about $420V \times 0.07Arms = 30W$, so the tube plates dissipate about $30 - 15W = 15W$, or about 8W each, which is about design level.

During dynamic conditions, the plate dissipation mostly exceeds the 10W power contour curve shown on the graph, however the average dissipation taken over both the "off" and 'on' periods brings this down significantly.

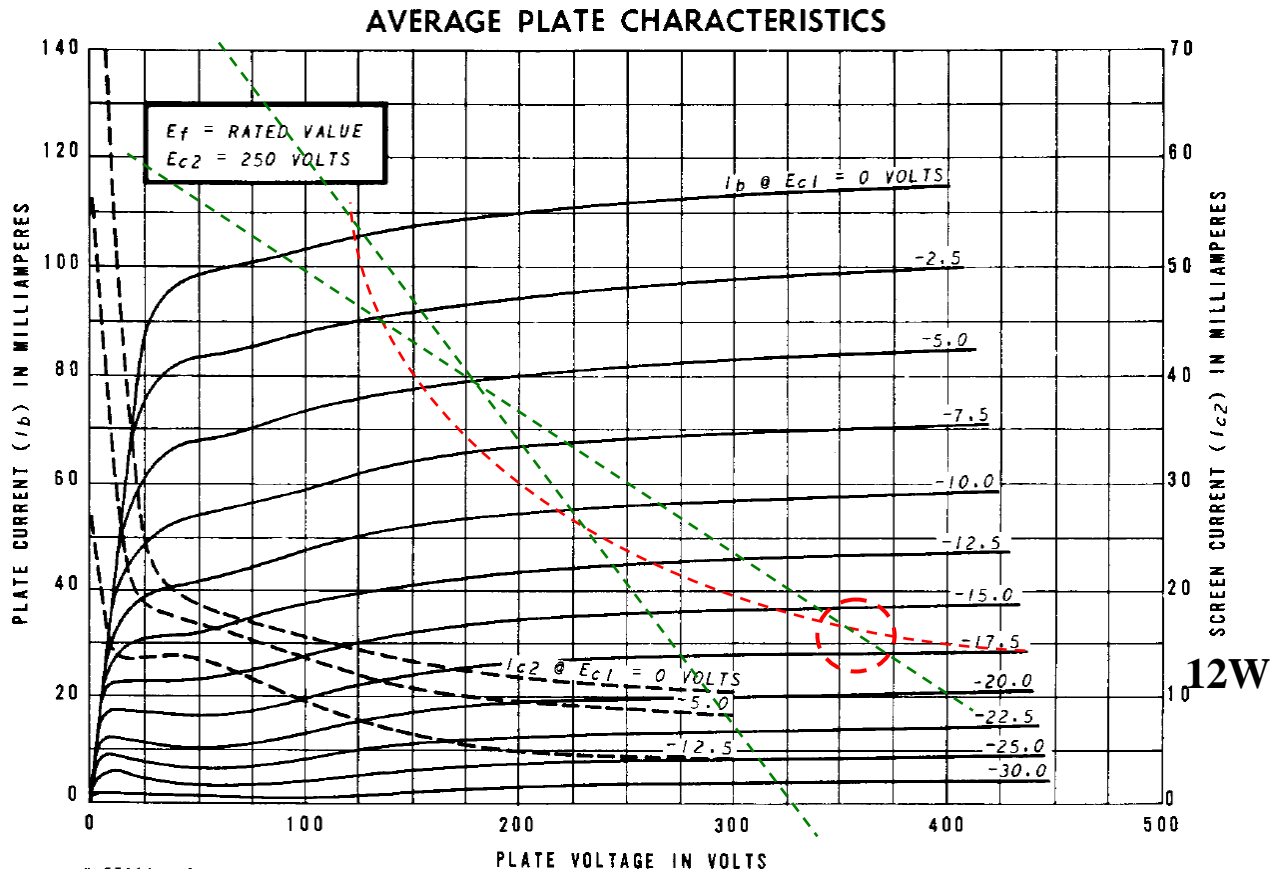

6V6 loadline for 3k8 – loading impedance possibly too low, although screen is 360V at idle.

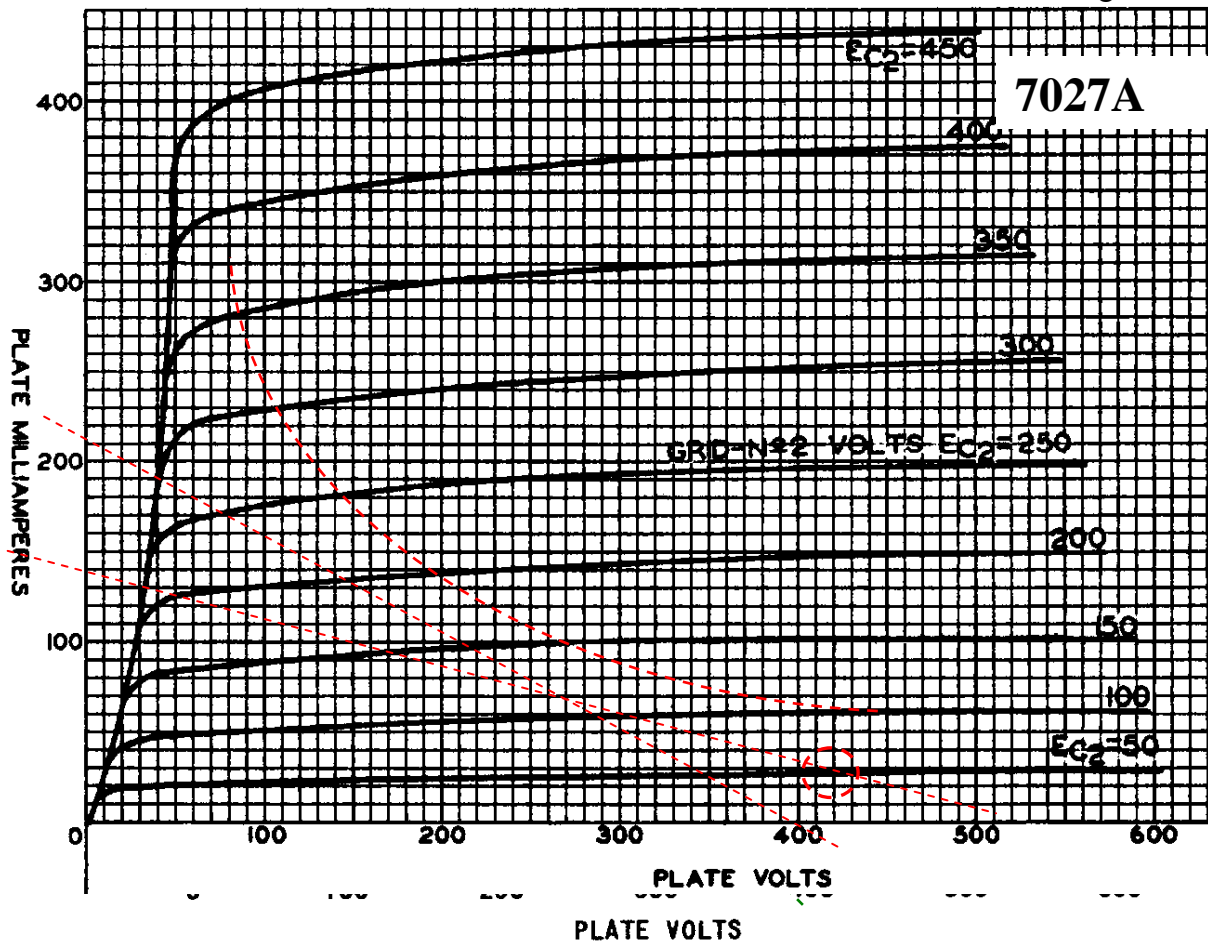

7027A loadline for 3k8 seems better

4.4 Power Supplies

6.3V heater #1 loading: $2 \times 0.45\text{A} = 0.9\text{A}$ for 6V6; $2 \times 0.9\text{A} = 1.8\text{A}$ for 6L6.

6.3V heater #2 loading: $3 \times 0.3\text{A}, 1 \times 0.6\text{A} = 1.5\text{A}$

5V heater loading: $1 \times 2\text{A} = 2\text{A}$

The 5V4 has limits on the effective source resistance when feeding a capacitor-input filter. The effective source resistance is comprised of the reflected power transformer primary resistance = $17\Omega \times (350/240)^2 = 36\Omega$; plus the secondary resistance = 120Ω ; which sums to 156Ω . The RCA datasheet indicates the effective source resistance should be 100Ω for a secondary supply of ?-?Vrms, based on $8\mu\text{F}$. The first filter cap is $8\mu\text{F}$, so appears fine.

475V at no load; 400V at 160mA. $10\mu\text{F}$ 350VAC +10% caps suitable for 500VDC, so used to replace all DC supply caps.

Choke DC drop at 70mA = 11V.

4.5 Protection

MOV-R protection of OT – $2 \times 330\text{VDC}$ and $2\text{k}\Omega$ per half-winding. RC corner frequency over 1MHz.

AUSTRALIAN SOUND SYSTEMS A13 AMPLIFIER - MODIFIED

S.N. 95

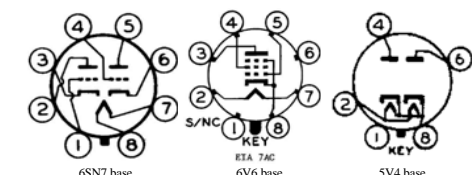
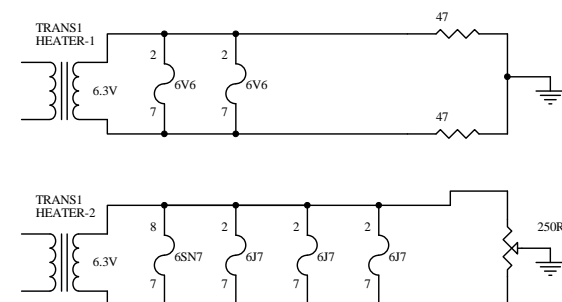
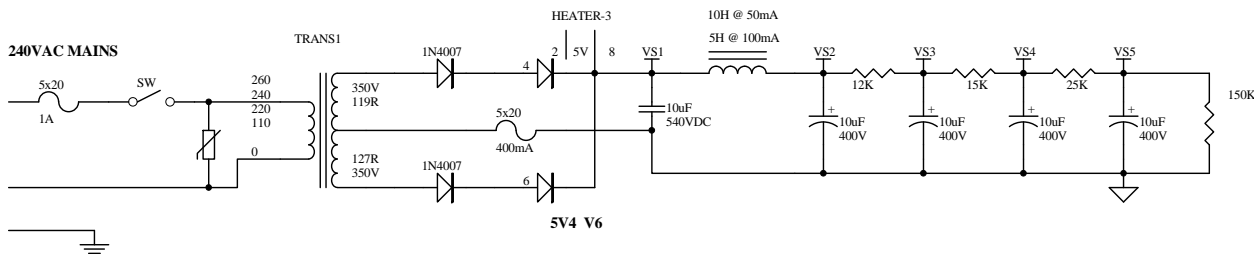
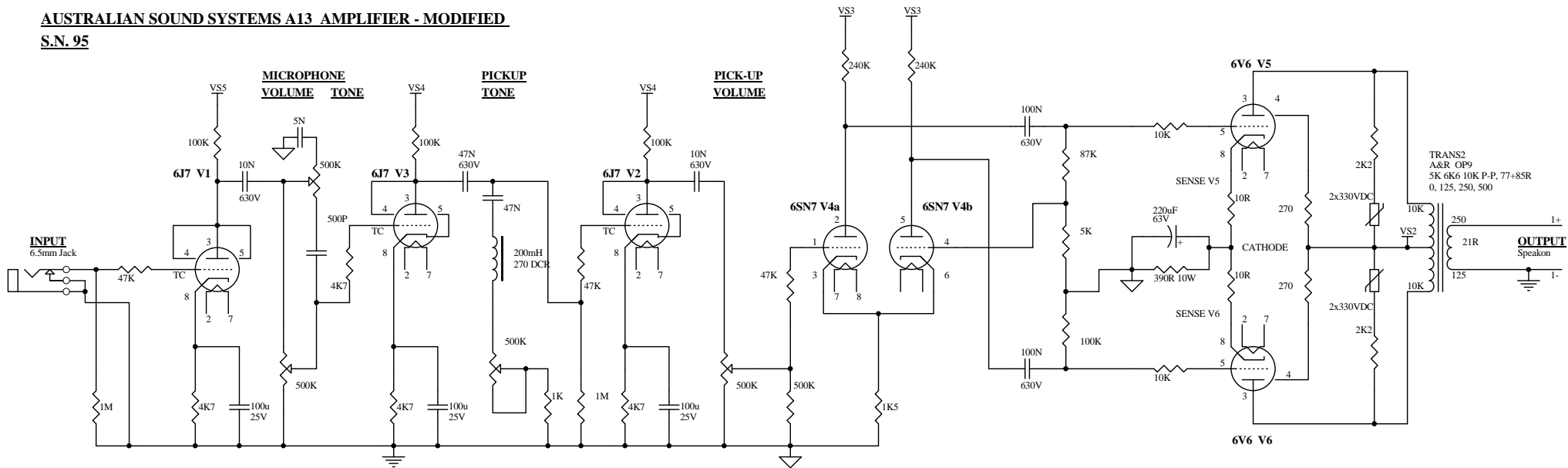

VOLTAGE RAILS		VALVE	QTY
RAIL	NO LOAD	6J7	3
VS1	400V	6SN7	1
VS2	385V	6V6	2
VS3	310V	5V4	1
VS4	250V		
VS5	195V		
HEATER-1	6.5V		
HEATER-2	6.3V		
HEATER-3	5V		
6V6 bias	35+35mA; 28V		

V1 on shock mount sockets

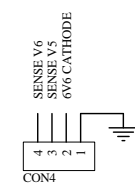

Title		
Size	Number	Revision
B		
Date:	29-Mar-2013	Sheet of
File:	\\sclient\C\Program Files\Design Explorer\906181\Projects\Amplifier Modules.ddb	